

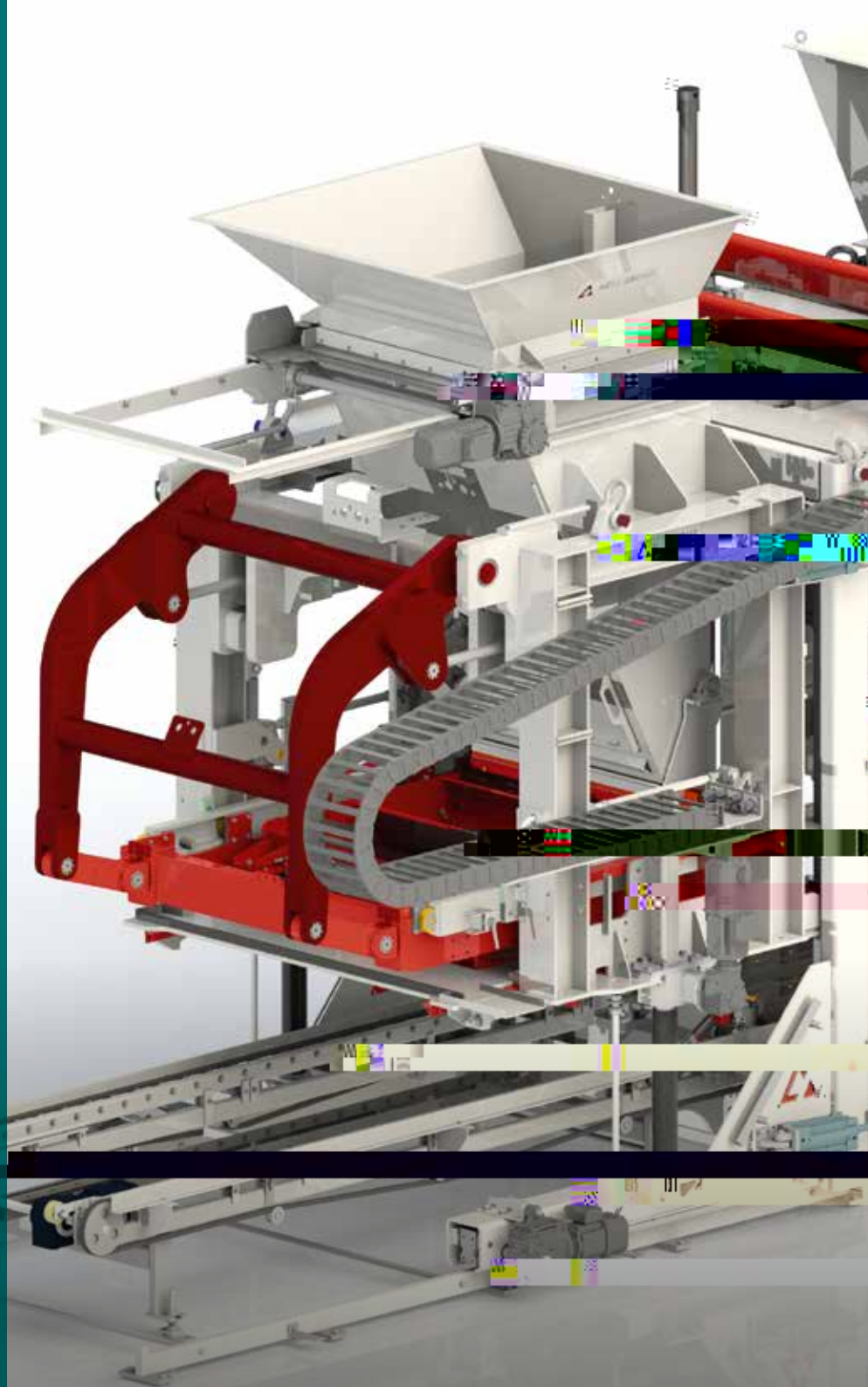

HESS GROUP

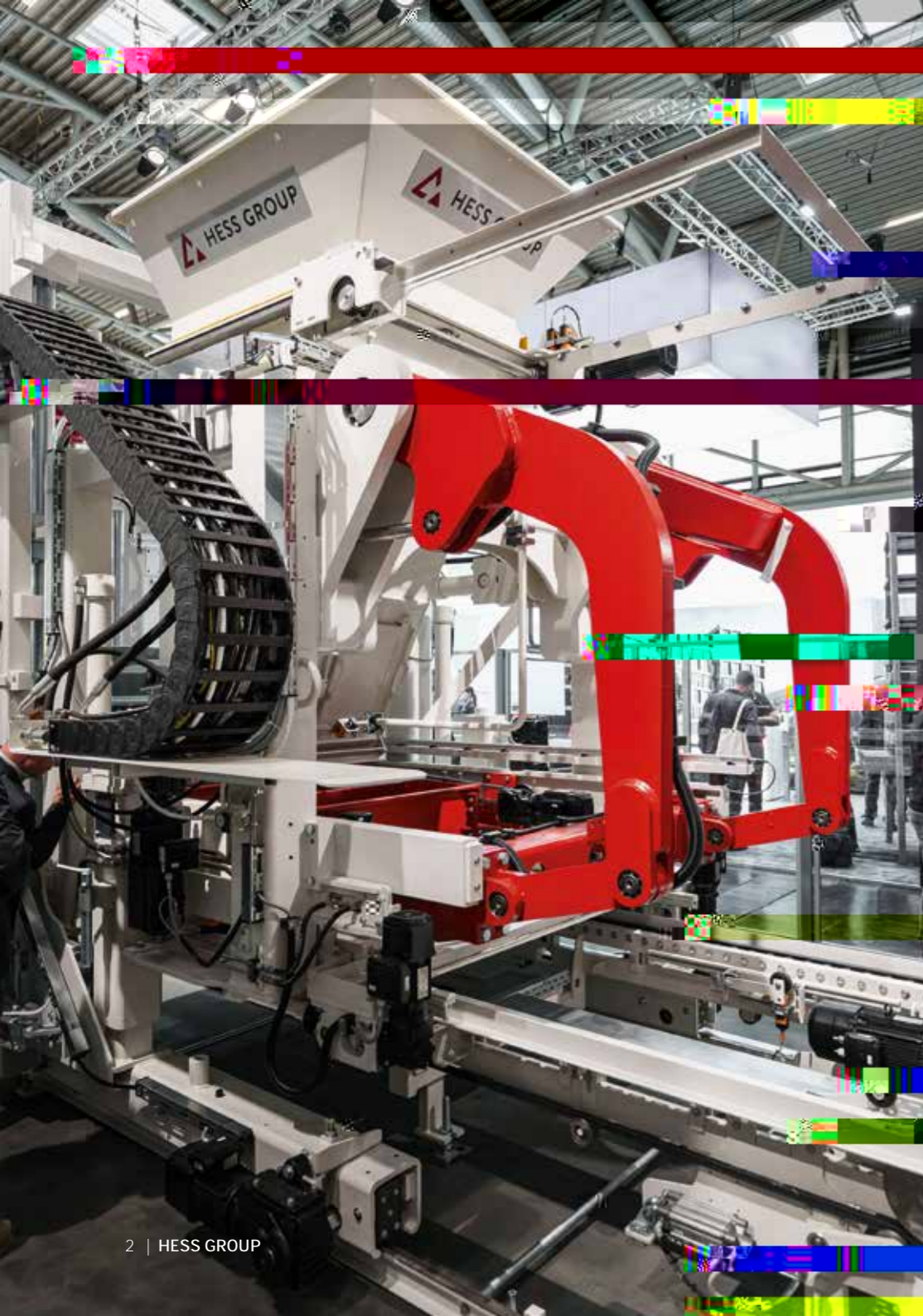



WER IST HESS GROUP?

HESS GROUP WELTWEIT

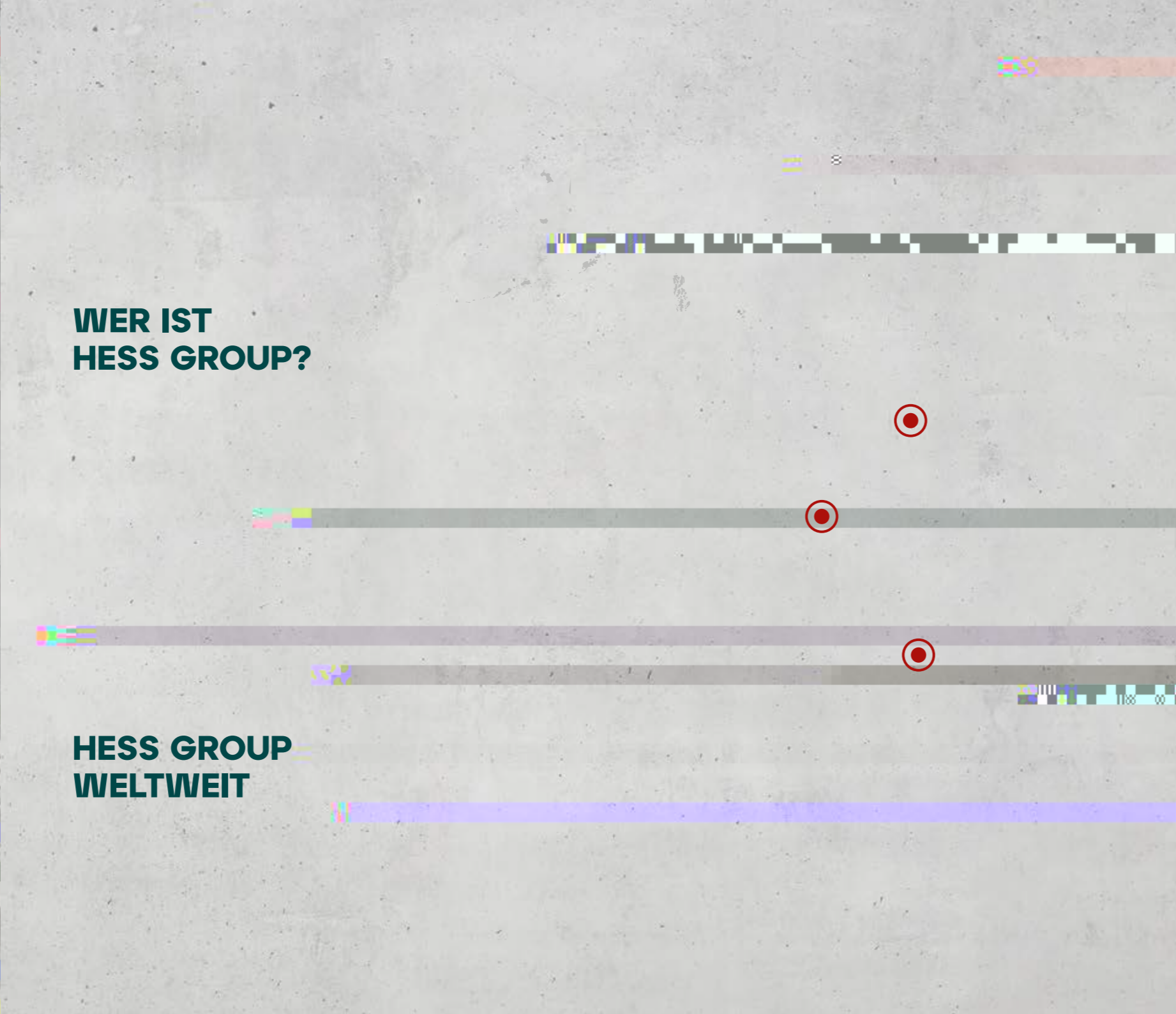

VISION

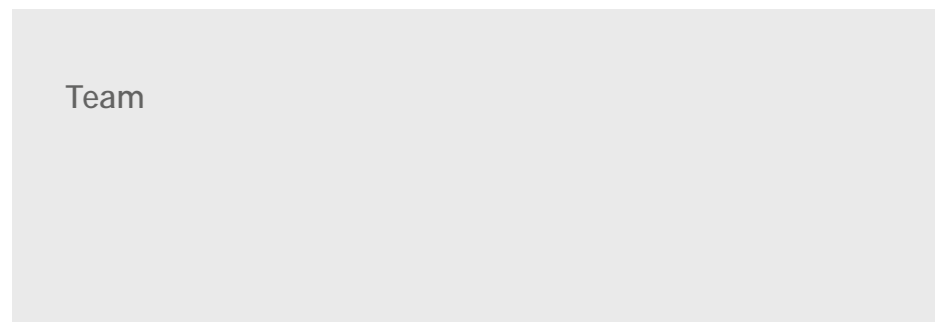
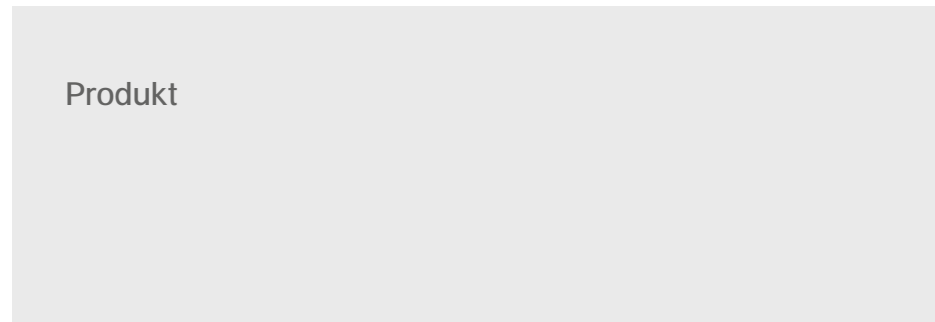

MISSION

effizient zu produzieren. Dabei stehen die folgenden 4 Faktoren im Vordergrund:

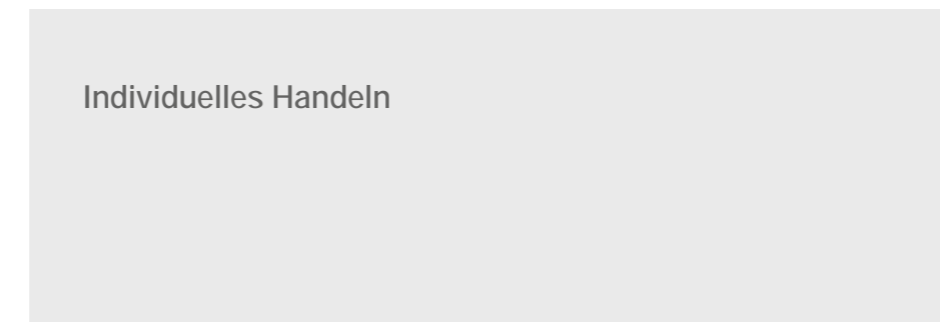
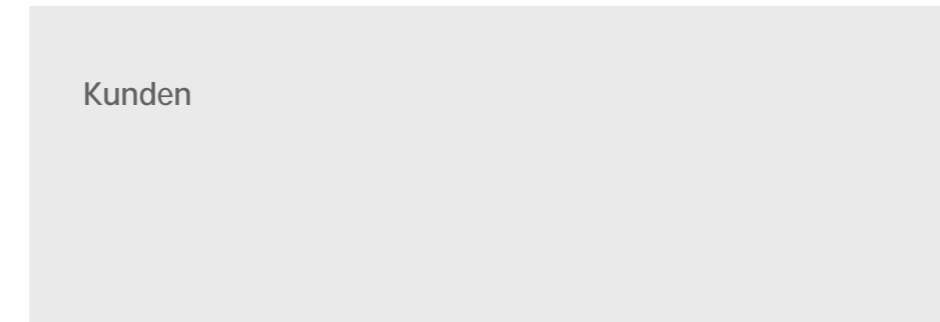

WERTE

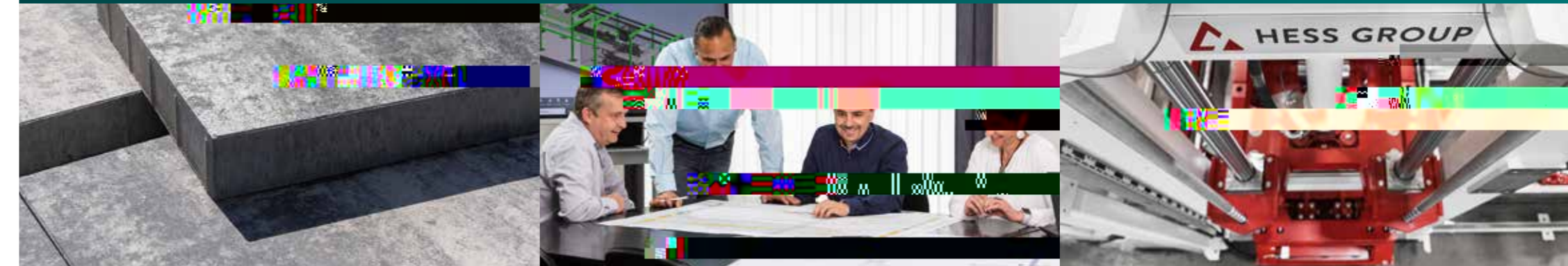

Qualität

Innovation

Kundenfokus



Als innovativer Hersteller hochwertiger
Betonsteinanlagen sichern wir –
gemeinsam mit unseren Kunden –
unsere beidseitige Marktführerschaft

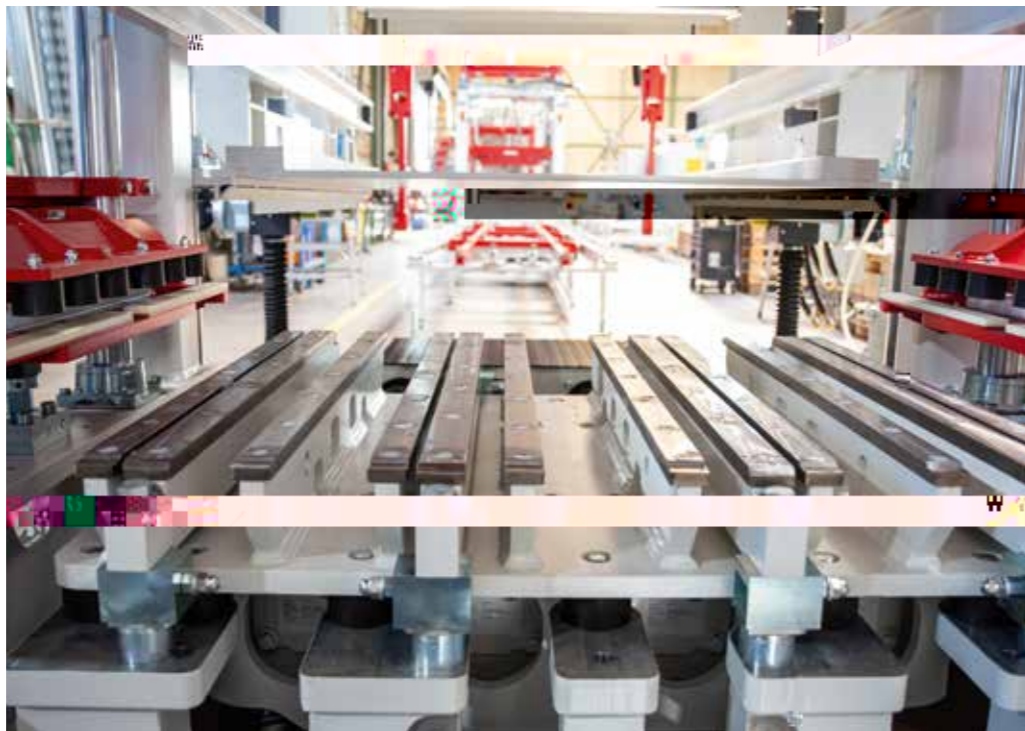
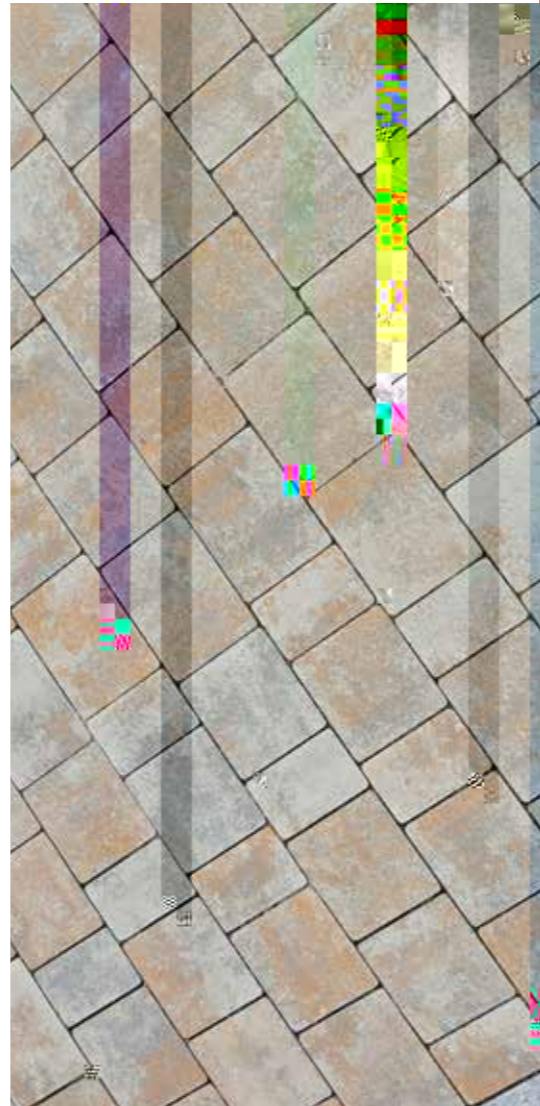
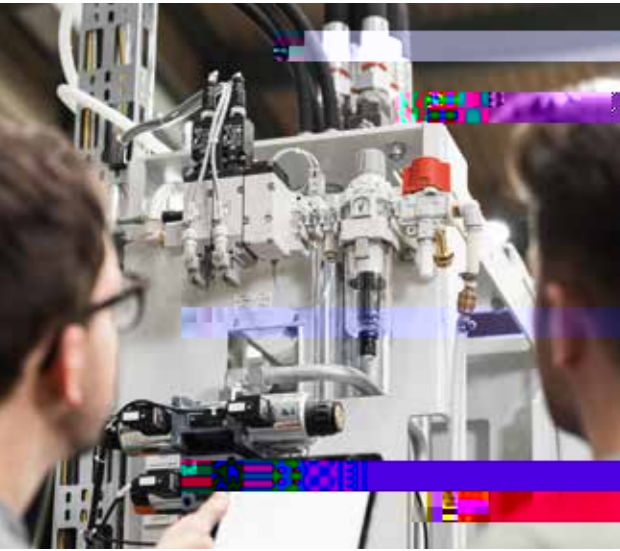

**WIR
BRINGEN
BETON
IN FORM.**

BETONSTEINMASCHINE
RH 1450



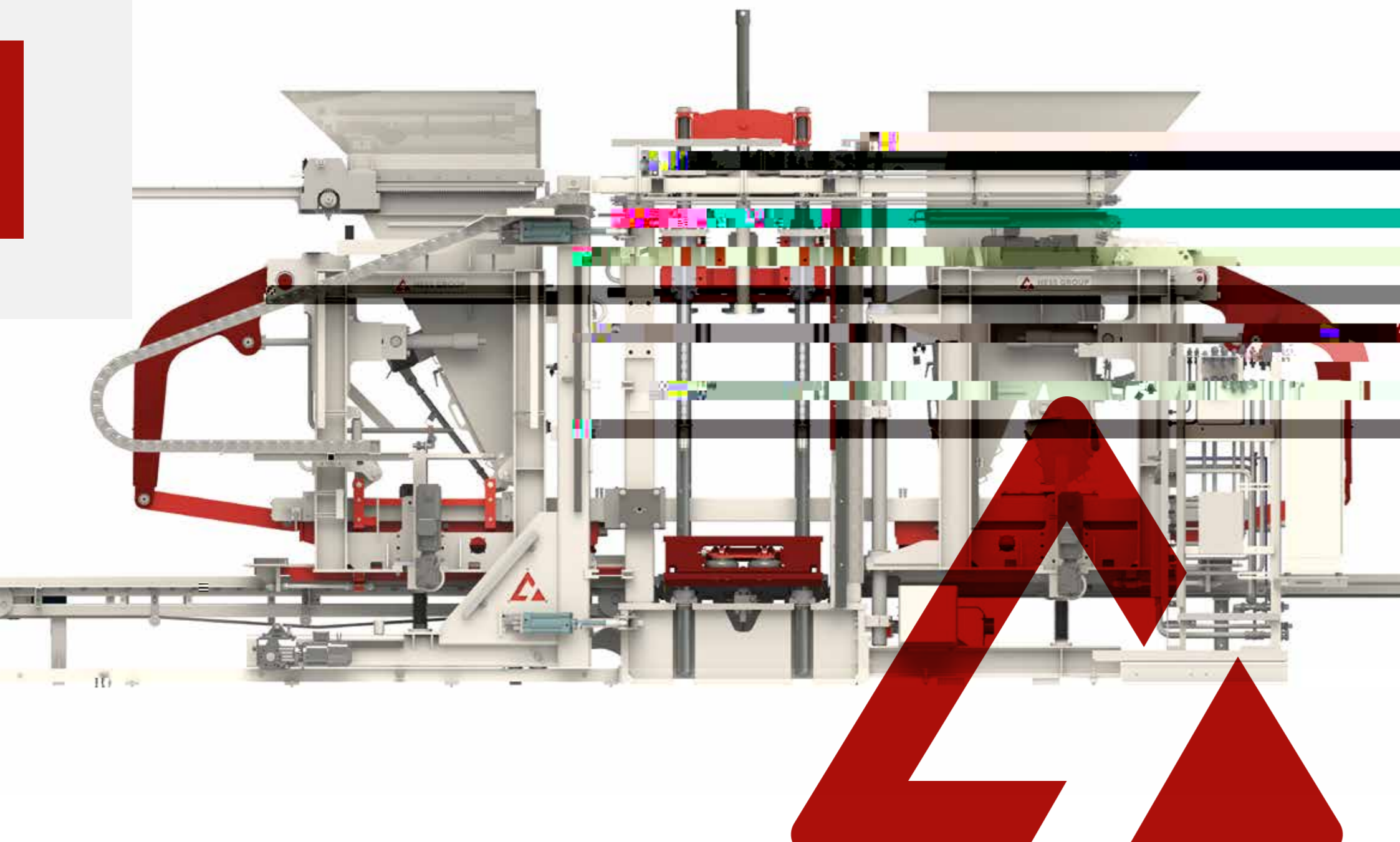

Die RH 1450 besticht durch ihre Kosteneffizienz, die sich

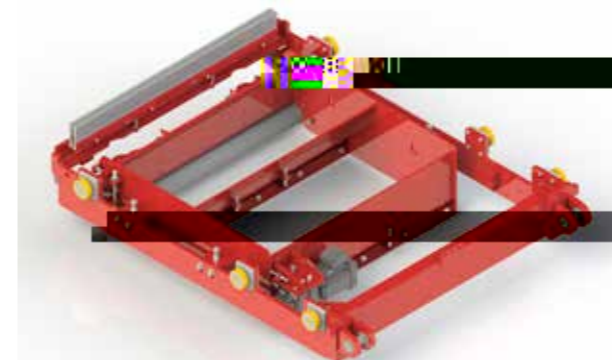
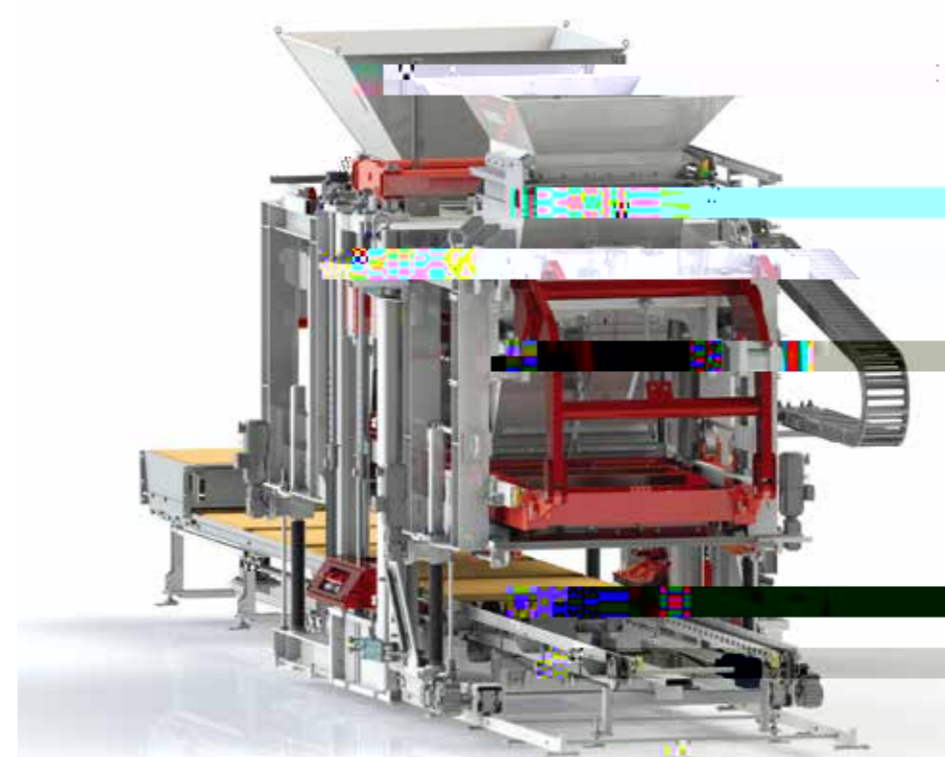

-
-
-



KOMPONENTEN

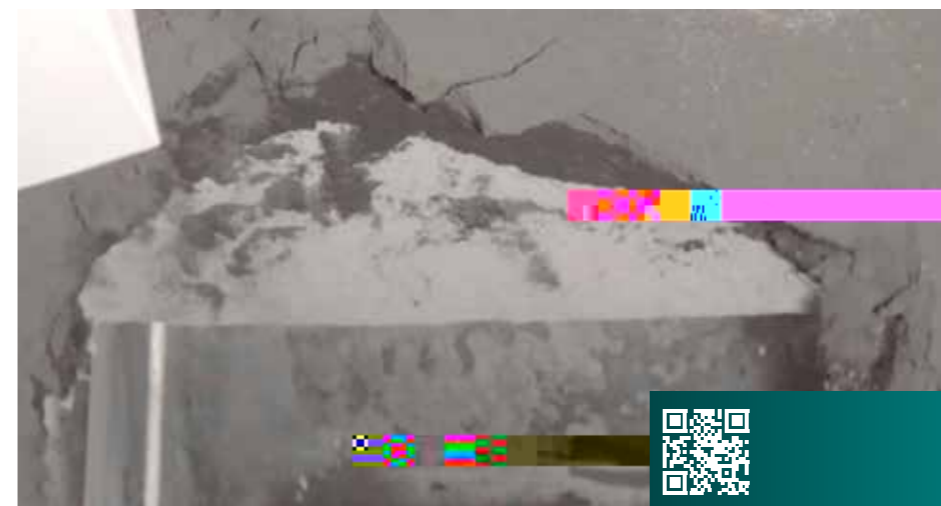
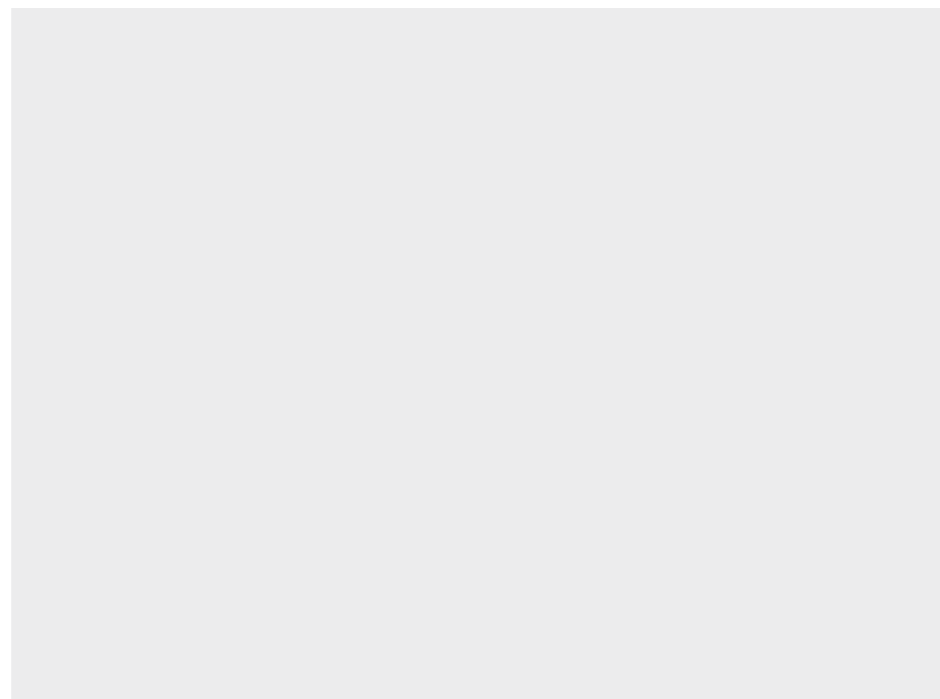
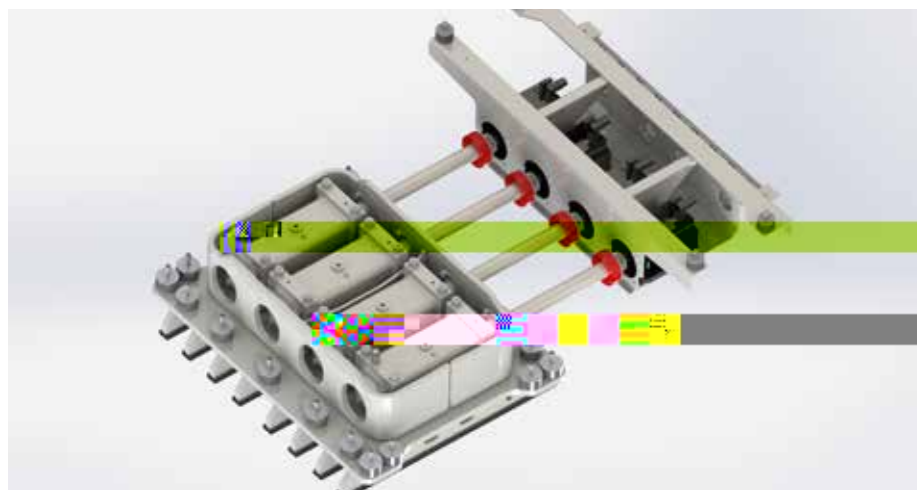
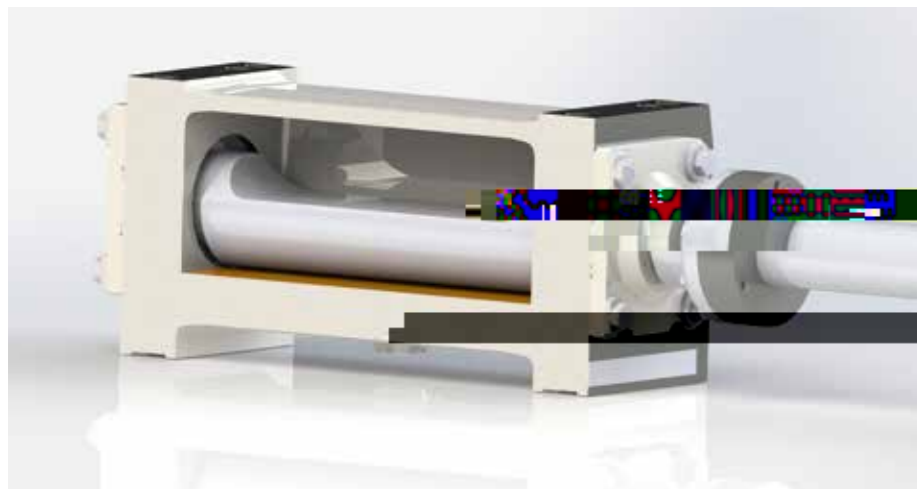



RH 1450 VA	

KOMPLETTANLAGEN

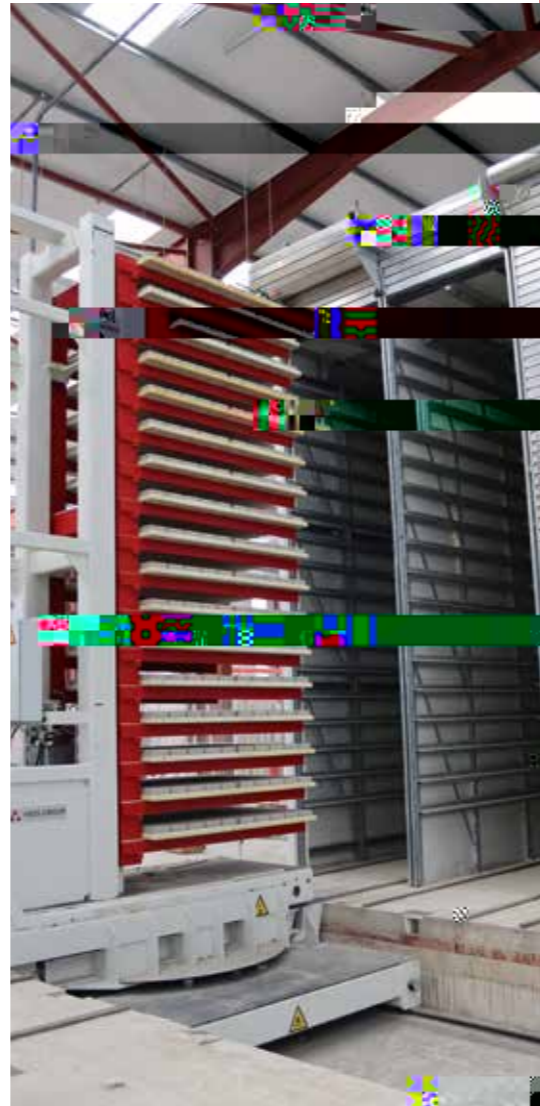
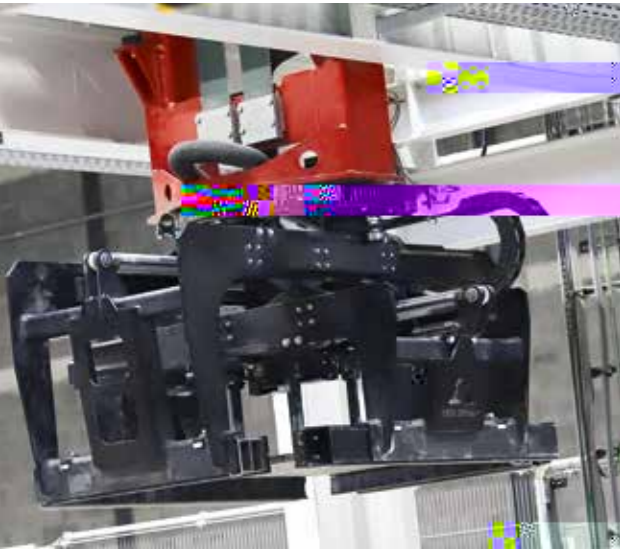

**WIR
BRINGEN
BETON
IN FORM.**

SONDERANLAGEN
**DOSIER- UND
MISCHANLAGEN,
FÖRDERTECHNIK UND
HANDLING**



**DOSIER- UND
MISCHANLAGEN**



Innenansicht Mischer mit Material

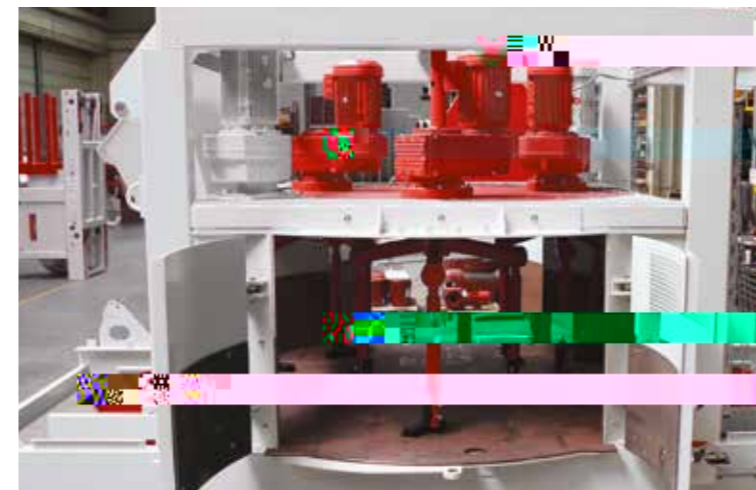

Innenansicht Mischer



Colormix Dosierstation

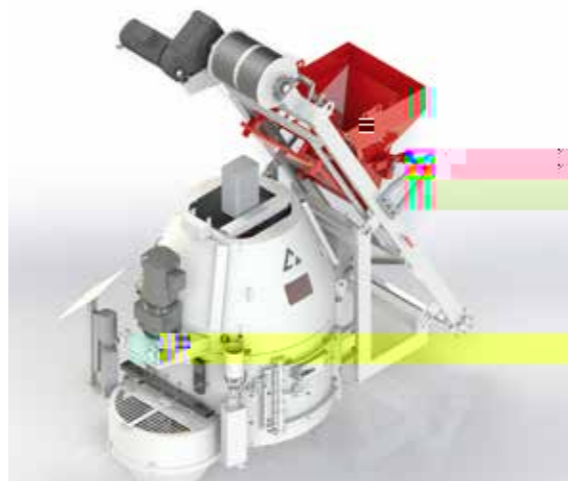

Vorsatzmischer SM 500

-
-
-



